



INTERSTATE-McBEE



Core Codes and Acceptance Guidelines



May 2021

Index

Core Return Guidelines 1

CAT®

Pencil Nozzles 2
 HEUI - 3126 3
 C7 4
 EUI - C10/C12 5
 EUI - 3406/C13/C15 6
 EUI - 3500 7

Cummins®

PT 8
 Celect 12
 ISX (HPI) 14

Detroit Diesel®

53/71/92/8.2 16
 Series 60 20-21
 DD13/15/16 21

Navistar®

HEUI 22
 G2.9 23

EMD

MUI 25-26
 Unacceptable Mechanical Injector Cores 27

EMD Racks 28



© Detroit Diesel is a registered trademark of the Detroit Diesel Corporation.
 © Caterpillar, CAT and HEUI are registered trademarks of Caterpillar, Inc.
 © Cummins and Cummins CELECT are registered trademarks of Cummins, Inc.
 © Navistar is a registered trademark of Navistar, Inc.

All manufacturer's names, numbers, symbols and descriptions are used for reference purposes only and does not imply that any part listed is the product of these manufacturers.

Core Return Guidelines

These items are applicable to ALL core returns:

1. All cores must be returned **freight prepaid** to:
Interstate-McBee
4901 Lakeside Ave.
Cleveland, OH. 44114
Attn: Core Return Department
International returns must be sent through customer's chosen freight forwarder as "DDP" (Delivery Duty Paid), including customs clearance paid and arrangement for pre-paid delivery all the way to the address above.
2. Cores must be received by Interstate-McBee no later than 60 days from date of invoice. Credit will not be issued for cores received after 60 days.
3. Only cores with the same group or core code classification as the exchange unit ordered will be acceptable (see <http://www.interstate-mcbee.com/warranty-policies.aspx> for Core Acceptance Catalog).
4. A packing list must be included with all core returns. The packing list must have company name, address, contact name and phone number plus detail quantity and identification of cores by one or more of the following:
 - a. Core code or core group
 - b. Part number
 - c. Interstate-McBee Invoice or Order number
5. If no invoice or order number is referenced on packing slip, credit will be issued to oldest outstanding invoice with corresponding exchange unit.
6. Core must be returned in protective packaging to prevent damage which may be caused during transportation.
7. Core must be in "off engine" condition as it was when originally removed from the engine.
8. Cores must be complete and cannot have been disassembled since being removed from the engine.
9. Cores damaged by non-operational causes such as rough handling, improper removal from the engine, fire or improper protection during storage will not be accepted.
10. Electronic injectors with broken stator terminals will not be accepted (see #9 above) unless otherwise noted in the Core Acceptance Catalog.
11. Light flash rust is acceptable, but heavy rust and/or pitting due to improper protection during storage is not acceptable.
12. Credit will be given only for cores owed. Additional cores received will be scrapped or returned at customer's expense. IMCB will not "Bank" excess cores.
13. The customer will be contacted by Interstate-McBee regarding any discrepancy and given 10 days to respond.
14. Broken tips (nozzles) on Cummins ISX & CAT 7000 (pencil) Series will NOT be acceptable, OK for all other.



INTERSTATE-McBEE



CAT® Pencil Nozzles



Example:
OR3422

Cores are Like for Like Part Number.
Any damage to the tip is NOT acceptable.
Must have Part Number on the body.



Blown Tip: Not Acceptable

Caterpillar 7000 Series Core (ORXXX)

These cores are only exchangeable by part number.

OE Part Number roll stamped here

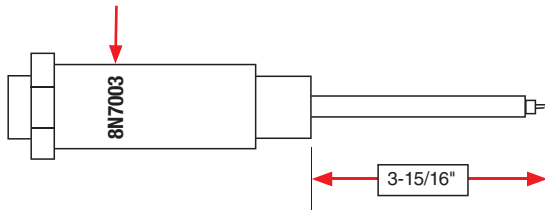

Caterpillar 7000 Series Cores with pushed in tops will not be accepted. Bent nozzles will also not be accepted. Any cores received with missing fuel lines will also not be accepted. Previously we could not accept any 7000 nozzle cores with a pushed out tip. Now some of these cores are acceptable but must measure within the specifications listed below.

When a new injector is rebuilt, OEM# should be "XXXXX" out. Reman numbers are typically etched on the major OD (can be very difficult to find & read)

Core Code	Reman Part Number	New Part Number		
C-OR3417	OR3417	8N7002	8N7003	
C-OR3418	OR3418	8N7001	8N7005	
C-OR3419	OR3419*	1W3996	4W7015	8N7004
C-OR3420	OR3420*	4W7010	4W7011	4W7016
C-OR3421	OR3421	4W7017	8N7007	
C-OR3422	OR3422	4W7012	4W7018	
C-OR3423	OR3423	7W7026		
C-OR3424	OR3424	7W7032		
C-OR3425	OR3425	7W7037		
C-OR3536	OR3536	4W7019		
C-OR3587	OR3587	7W7041		
C-OR3588	OR3588	7W7042		
C-OR3591	OR3591	7W7045	170-5181	
C-OR4337	OR4337	100-7550	100-7556	100-7600
C-OR4339	OR4339	100-7558		
C-OR8243	OR8243	131-1243		
C-OR8290	OR8290	100-7567	127-9793	
C-OR8785	OR8785	7W7031		

*MUST have the fuel lines attached. Pictured below:



Example:
OR3419
OR3420

© Caterpillar, CAT and HEUI are registered trademarks of Caterpillar, Inc.

All manufacturer's names, numbers, symbols and descriptions are used for reference purposes only and does not imply that any part listed is the product of these manufacturers.



INTERSTATE-McBEE



CAT® HEUI - 3126



Example: 10R0781

Core Code	C-3126BTYPE1		C-3126BTYPE2		
Part Numbers	1459360	2033771	1260499	1774754	2051286
	1551819	2046714	1317150	1780198	2225926
	1731012	2225963	1417837	1780199	2225967
	1734566	2225965	1731013	1961401	2225972
	1739379	0R9348	1734059	1964229	0R9349
	1881320	10R1262	1739267	1977107	0R9350
			1739268	1986605	10R0781
			1739272	1996065	10R0782

A cracked stator is NOT ACCEPTABLE.

The connector at the top of the injector must be intact. If it is broken or chipped the core is NOT ACCEPTABLE.

The picture below is an acceptable connector.



Note the differences in the clamp holders.

In both pictures below, 3126B (HEUI) on Left and Navistar (HEUI) on the right.



IDS Core Code	OE Reman Part Number	OE New Part Number
C-761	10R4761	222-5959
		222-5961
		223-3536
		236-0973
		241-3238
		264-4502
		295-1408
		328-2583
387-9430		
C-762	10R4762	222-5962
		238-9808
		238-9809
		241-3239
		243-4503
		295-1409
		328-2584
		387-9429
C-763	10R4763	222-5958
		231-3400
		233-3535
		236-0974
		238-8091
		241-3400
		246-2343
		295-1410
		328-2582
		387-9428



Location of the part number.

Connector must not be cracked or broken.

© Caterpillar, CAT and HEUI are registered trademarks of Caterpillar, Inc.

All manufacturer's names, numbers, symbols and descriptions are used for reference purposes only and does not imply that any part listed is the product of these manufacturers.



INTERSTATE-McBEE



CAT® EUI - C10/C12

Core Code	Eligible Part Numbers	
C-1012A	2123464	10R0725
C-1012B	1165426 2123465	
C-1012C	1372500 1470373 1601090 1602303 1945083 2123463	10R0963
C-1012D	2123461	10R0966
C-1012E	1165414 1611785 2123462	10R0967
C-1012F	1165425 1561011 2123466	10R0968



Location of Part Number



INTERSTATE-McBEE



© Caterpillar, CAT and HEUI are registered trademarks of Caterpillar, Inc.

All manufacturer's names, numbers, symbols and descriptions are used for reference purposes only and does not imply that any part listed is the product of these manufacturers.

CAT® EUI - 3406E/C-Series

New Core Code	Eligible Part Numbers			
C-131	249-0708			10R2977
C-3406E1	102-6236 109-5038 117-0481 118-7929 118-9027	140-8951 159-2631 191-3002 211-3022	0R4332 0R4895 0R9256	10R0956 10R2782
C-3406E2	102-2014 103-4562 109-5021 117-0482 118-8010	118-9030 140-8993 159-2479 191-3003 211-3023	0R4119 0R4300 0R4331 0R4894 0R9257	10R0957 10R2781 10R8501
C-3406E3	102-6230 117-1146 117-1148 118-9035	152-3680 191-3004 211-3024 211-3027	0R4118 0R4668 0R4893 0R9258	10R0958 10R2780 10R8502
C-151	229-5919			10R1000
C-152	211-3025			10R0955
C-153	239-4909 249-0709			10R1273 10R9236
C-154	3740750 3740751	2530617 2447717	20R2285 20R2284	10R3266



Injector Part Number can be found in 1 of 2 locations:

Stator



Follower
(to the left)



© Caterpillar, CAT and HEUI are registered trademarks of Caterpillar, Inc.

All manufacturer's names, numbers, symbols and descriptions are used for reference purposes only and does not imply that any part listed is the product of these manufacturers.



INTERSTATE-McBEE



CAT® EUI - 3500

All CAT 3500 EUI with a 1 piece nozzle nut are acceptable cores. Core Code is C-3500.
 Notice the difference in the angle of the stator/body between CAT 3500 and CAT 3406/C15 on previous page:

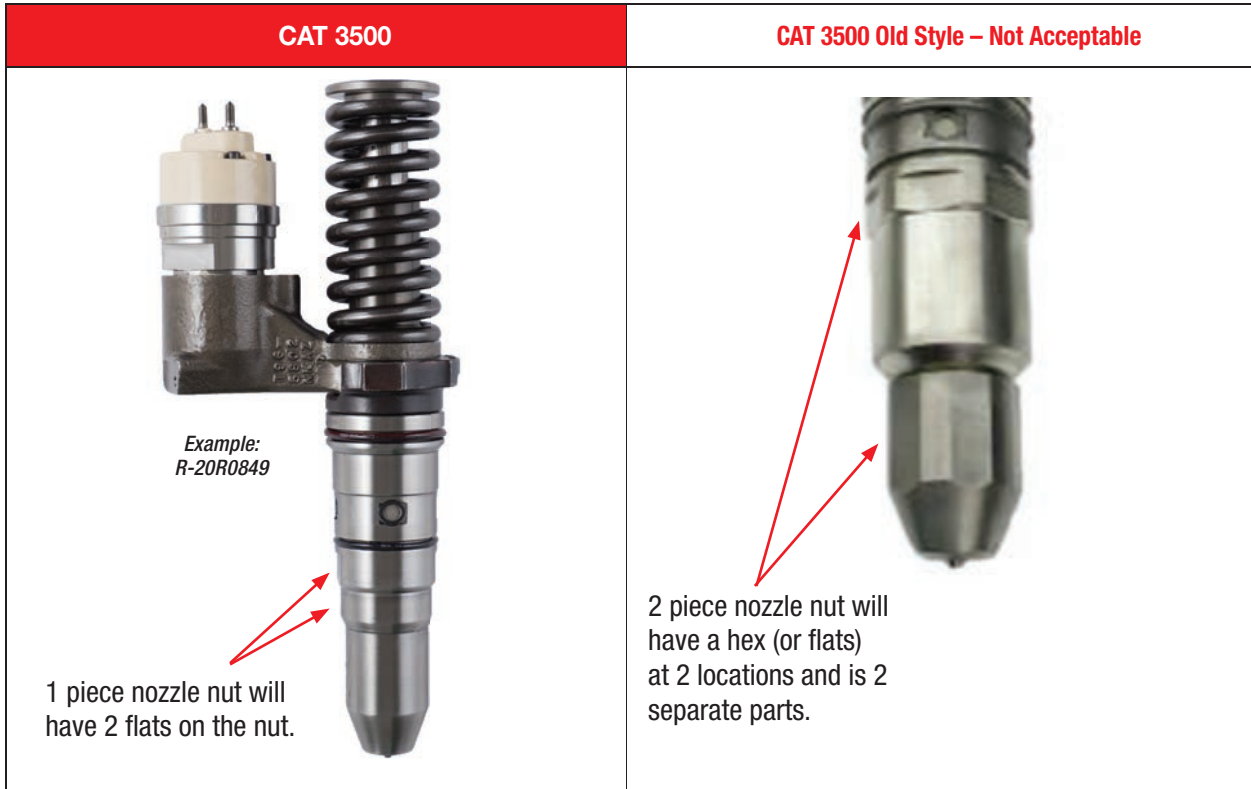

New Number	Reman Number
2309457	10R3255
2458272	10R8795
2461854	10R7238
2481079	10R7235
2490746	10R2826
2490747	10R2827
2501300	10R1284
2501301	10R3256
2501302	10R1303
2501303	10R1276
2501304	10R1278
2501305	10R7237
2501306	10R1288
2501307	10R1277
2501308	10R1280
2501309	10R3258

New Number	Reman Number
2501310	10R7233
2501311	10R1279
2501312	10R1275
2501313	10R1285
2501314	10R1290
2501315	10R1291
2501368	10R7234
2530692	10R7239
2693152	10R8987
3619355	20R0850
3619355	20R1111
3734087	20R0848
3760509	20R0849
3760511	20R0863
3760513	20R0864
3861757	20R1269

New Number	Reman Number
3861758	20R1270
3861759	20R1271
3861760	20R1272
3861761	20R1273
3861762	20R1274
3861766	20R1275
3861767	20R1276
3861768	20R1277
3861769	20R1278
3861770	20R1279
3861771	20R1280
3861772	20R1281
3861774	20R1282
3861776	20R1283
3861778	20R1262
3861779	20R1263

New Number	Reman Number
3920200	20R1264
3920201	20R1265
3920202	20R1266
3920203	20R1267
3920204	20R1268
3920213	20R1925
4237547	20R2296





INTERSTATE-McBEE



© Caterpillar, CAT and HEUI are registered trademarks of Caterpillar, Inc.

All manufacturer's names, numbers, symbols and descriptions are used for reference purposes only and does not imply that any part listed is the product of these manufacturers.

C-PTD	C-30B	C-41K
 <p>3/8" Exposed</p> <p>5-3/4"</p> <p><i>Example: M-3007465</i></p>	 <p>1-1/4" Exposed</p> <p>5-1/4"</p> <p><i>Example: R-3275537</i></p>	 <p>1-1/4" Exposed</p> <p>7-1/4"</p> <p><i>Example: R-3016676</i></p>
<p>This is a Cummins standard PTD core. Note that the spring is slightly exposed.</p>	<p>This is a Cummins 5/16 PTD core. It is smaller than the standard PTD core with a more exposed spring.</p>	<p>This is a Cummins K PTD core. This core is longer than the standard PTD core and the spring is much more exposed</p>
C-T/S		C-36B
 <p>Flange</p> <p>6"</p> <p><i>Example: R-3047977</i></p>		 <p>Groove</p> <p>6"</p> <p><i>Example: R-3056342</i></p>
<p>This is a Cummins standard Top Stop (T/S) core. Notice that the core does not have a visible spring on the top.</p>		<p>This is a Cummins L10 T/S injector core. It is very similar to the standard T/S core, but the standard T/S has a flange near the top, while the L10 has a groove. If in doubt, check the part number stamped on the injector.</p>

OK for the plunger to be missing. OK for the cup to be damaged.



Cummins® Core Codes

Product No.	Description	Core Code
R-3003942	REB INJECTOR,PTD	C-PTD
R-3004468	REB INJECTOR,PTD	C-PTD
R-3004908	REB INJECTOR,T/S	C-T/S
R-3007461	REB INJECTOR,PTD	C-PTD
R-3007462	REB INJECTOR,PTD	C-PTD
R-3007464	REB INJECTOR,PTD	C-PTD
R-3007465	REB INJECTOR,PTD	C-PTD
R-3007468	REB INJECTOR,PTD	C-PTD
R-3007471	REB INJECTOR,PTD	C-PTD
R-3007472	REB INJECTOR,PTD	C-PTD
R-3007473	REB INJECTOR,PTD	C-PTD
R-3007474	REB INJECTOR,PTD	C-PTD
R-3007475	REB INJECTOR,PTD	C-PTD
R-3007476	REB INJECTOR,PTD	C-PTD
R-3007477	REB INJECTOR,PTD	C-PTD
R-3007478	REB INJECTOR,PTD	C-PTD
R-3007495	REB INJECTOR,PTD	C-PTD
R-3007497	REB INJECTOR,PTD	C-PTD
R-3008526	REB INJECTOR,PTD	C-PTD
R-3008527	REB INJECTOR,PTD	C-PTD
R-3008528	REB INJECTOR,PTD	C-PTD
R-3008529	REB INJECTOR,PTD	C-PTD
R-3008899	REB INJECTOR,K,DFF	C-41K
R-3009565	REB INJECTOR,PTD	C-PTD
R-3011967	REB INJECTOR,PTD	C-PTD
R-3011969	REB INJECTOR,PTD	C-PTD
R-3011981	REB INJECTOR,PTD	C-PTD
R-3011987	REB INJECTOR,PTD	C-PTD
R-3011988	REB INJECTOR,PTD	C-PTD
R-3011989	REB INJECTOR,PTD	C-PTD
R-3013725	REB INJECTOR,PTD	C-PTD
R-3014925	REB INJECTOR,T/S	C-T/S
R-3016675	REB INJECTOR,K,DFF	C-41K
R-3016676	REB INJECTOR,K,DFF	C-41K
R-3017383	REB INJECTOR,PTD	C-PTD
R-3018217	REB INJECTOR,PTD DFF	C-PTD
R-3018220	REB INJECTOR,PTD	C-PTD
R-3018223	REB INJECTOR,PTD	C-PTD

Product No.	Description	Core Code
R-3018224	REB INJECTOR,PTD	C-PTD
R-3018225	REB INJECTOR,PTD	C-PTD
R-3018321	REB INJECTOR,T/S	C-T/S
R-3018323	REB INJECTOR,PTD	C-PTD
R-3018328	REB INJECTOR,PTD	C-PTD
R-3018329	REB INJECTOR,T/S	C-T/S
R-3018331	REB INJECTOR,T/S DFF	C-T/S
R-3018332	REB INJECTOR,T/S	C-T/S
R-3018333	REB INJECTOR,T/S DFF	C-T/S
R-3018334	REB INJECTOR,T/S	C-T/S
R-3018335	REB INJECTOR,T/S DFF	C-T/S
R-3018336	REB INJECTOR,T/S	C-T/S
R-3018339	REB INJECTOR,T/S	C-T/S
R-3018340	REB INJECTOR,T/S	C-T/S
R-3018343	REB INJECTOR,T/S	C-T/S
R-3018346	REB INJECTOR,T/S	C-T/S
R-3018347	REB INJECTOR,T/S DFF	C-T/S
R-3018348	REB INJECTOR,T/S	C-T/S
R-3018349	REB INJECTOR,T/S DFF	C-T/S
R-3018350	REB INJECTOR,T/S	C-T/S
R-3018351	REB INJECTOR,T/S DFF	C-T/S
R-3018352	REB INJECTOR,T/S	C-T/S
R-3018353	REB INJECTOR,T/S DFF	C-T/S
R-3018354	REB INJECTOR,T/S	C-T/S
R-3018355	REB INJECTOR,T/S DFF	C-T/S
R-3018356	REB INJECTOR,T/S	C-T/S
R-3018372	REB INJECTOR,T/S	C-T/S
R-3018566	REB INJECTOR,PTD	C-PTD
R-3018567	REB INJECTOR,PTD	C-PTD
R-3018568	REB INJECTOR,PTD	C-PTD
R-3018572	REB INJECTOR,PTD	C-PTD
R-3018575	REB INJECTOR,T/S	C-T/S
R-3018815	REB INJECTOR,PTD	C-PTD
R-3018816	REB INJECTOR,PTD	C-PTD
R-3018822	REB INJECTOR,PTD	C-PTD
R-3018823	REB INJECTOR,PTD	C-PTD
R-3018824	REB INJECTOR,PTD	C-PTD
R-3018825	REB INJECTOR,PTD	C-PTD



INTERSTATE-McBEE



© Cummins and Cummins CELECT are registered trademarks of Cummins, Inc.

All manufacturer's names, numbers, symbols and descriptions are used for reference purposes only and does not imply that any part listed is the product of these manufacturers.

Cummins® Core Codes

Product No.	Description	Core Code
R-3018826	REB INJECTOR,PTD	C-PTD
R-3018827	REB INJECTOR,PTD	C-PTD
R-3018828	REB INJECTOR,PTD	C-PTD
R-3018829	REB INJECTOR,PTD	C-PTD
R-3018831	REB INJECTOR,PTD	C-PTD
R-3018832	REB INJECTOR,PTD	C-PTD
R-3018833	REB INJECTOR,PTD	C-PTD
R-3018834	REB INJECTOR,PTD	C-PTD
R-3018835	REB INJECTOR,PTD	C-PTD
R-3018836	REB INJECTOR,T/S	C-T/S
R-3018837	REB INJECTOR,T/S	C-T/S
R-3018838	REB INJECTOR,PTD	C-PTD
R-3018839	REB INJECTOR,PTD	C-PTD
R-3018840	REB INJECTOR,PTD	C-PTD
R-3018841	REB INJECTOR,PTD	C-PTD
R-3018843	REB INJECTOR,PTD	C-PTD
R-3018844	REB INJECTOR,PTD	C-PTD
R-3018845	REB INJECTOR,PTD	C-PTD
R-3018848	REB INJECTOR,PTD	C-PTD
R-3018851	REB INJECTOR,PTD	C-PTD
R-3018852	REB INJECTOR,PTD	C-PTD
R-3018853	REB INJECTOR,PTD	C-PTD
R-3018854	REB INJECTOR,PTD	C-PTD
R-3019932	REB INJECTOR,PTD	C-PTD
R-3020900	REB INJECTOR,PTD DFF	C-PTD
R-3020964	REB INJECTOR,PTD	C-PTD
R-3020966	REB INJECTOR,PTD	C-PTD
R-3022197	REB INJECTOR,K,DFF	C-41K
R-3022268	REB INJECTOR,T/S	C-T/S
R-3023008	REB INJECTOR,PTD	C-PTD
R-3023014	REB INJECTOR,PTD	C-PTD
R-3023016	REB INJECTOR,PTD	C-PTD
R-3023035	REB INJECTOR,K,DFF	C-41K
R-3023233	REB INJECTOR,T/S	C-T/S
R-3023554	REB INJECTOR,T/S	C-T/S
R-3023557	REB INJECTOR,T/S	C-T/S
R-3024147	REB INJECTOR,T/S	C-T/S
R-3024637	REB INJECTOR,T/S	C-T/S

Product No.	Description	Core Code
R-3024638	REB INJECTOR,T/S	C-T/S
R-3026074	REB INJECTOR,PTD DFF	C-PTD
R-3030445	REB INJECTOR,T/S DFF	C-T/S
R-3032226	REB INJECTOR,T/S DFF	C-T/S
R-3034619	REB INJECTOR,T/S DFF	C-T/S
R-3037338	REB INJECTOR,T/S DFF	C-T/S
R-3040912	REB INJECTOR,T/S DFF	C-T/S
R-3041836	REB INJECTOR,T/S DFF	C-T/S
R-3043545	REB INJECTOR,T/S DFF	C-T/S
R-3045102	REB INJECTOR,L10,T/S DFF	C-36B
R-3046281	REB INJECTOR,T/S DFF	C-T/S
R-3047966	REB INJECTOR,T/S DFF	C-T/S
R-3047967	REB INJECTOR,T/S DFF	C-T/S
R-3047968	REB INJECTOR,T/S DFF	C-T/S
R-3047969	REB INJECTOR,T/S DFF	C-T/S
R-3047970	REB INJECTOR,T/S DFF	C-T/S
R-3047971	REB INJECTOR,T/S DFF	C-T/S
R-3047973	REB INJECTOR,T/S DFF	C-T/S
R-3047974	REB INJECTOR,T/S DFF	C-T/S
R-3047975	REB INJECTOR,T/S DFF	C-T/S
R-3047976	REB INJECTOR,T/S DFF	C-T/S
R-3047977	REB INJECTOR,T/S DFF	C-T/S
R-3047978	REB INJECTOR,T/S DFF	C-T/S
R-3047979	REB INJECTOR,T/S DFF	C-T/S
R-3047980	REB INJECTOR,T/S DFF	C-T/S
R-3047981	REB INJECTOR,T/S DFF	C-T/S
R-3047982	REB INJECTOR,T/S DFF	C-T/S
R-3047983	REB INJECTOR,T/S DFF	C-T/S
R-3047984	REB INJECTOR,T/S DFF	C-T/S
R-3047985	REB INJECTOR,PTD DFF	C-PTD
R-3047987	REB INJECTOR,PTD DFF	C-PTD
R-3047989	REB INJECTOR,PTD DFF	C-PTD
R-3047991	REB INJECTOR,PTD DFF	C-PTD
R-3047992	REB INJECTOR,PTD DFF	C-PTD
R-3048503	REB INJECTOR,PTD DFF	C-PTD
R-3049149	REB INJECTOR,L10,T/S DFF	C-36B
R-3049429	REB INJECTOR,L10,T/S DFF	C-36B
R-3052255	REB INJECTOR,K,DFF	C-42K

© Cummins and Cummins CELECT are registered trademarks of Cummins, Inc.

All manufacturer's names, numbers, symbols and descriptions are used for reference purposes only and does not imply that any part listed is the product of these manufacturers.



INTERSTATE-McBEE



Cummins® Core Codes

Product No.	Description	Core Code
R-3053124	REB INJECTOR,K,DFF	C-41K
R-3054058	REB INJECTOR,PTD DFF	C-PTD
R-3054068	REB INJECTOR,T/S DFF	C-T/S
R-3054071	REB INJECTOR,T/S DFF	C-T/S
R-3054072	REB INJECTOR,PTD DFF	C-T/S
R-3054073	REB INJECTOR,T/S DFF	C-T/S
R-3054074	REB INJECTOR,PTD DFF	C-PTD
R-3054086	REB INJECTOR,PTD DFF	C-PTD
R-3054088	REB INJECTOR,PTD DFF	C-PTD
R-3054094	REB INJECTOR,T/S DFF	C-T/S
R-3054095	REB INJECTOR,T/S DFF	C-T/S
R-3054096	REB INJECTOR,T/S DFF	C-T/S
R-3054097	REB INJECTOR,T/S DFF	C-T/S
R-3054197	REB INJECTOR,PTD DFF	C-PTD
R-3054204	REB INJECTOR,PTD DFF	C-PTD
R-3054205	REB INJECTOR,PTD DFF	C-PTD
R-3054208	REB INJECTOR,PTD DFF	C-PTD
R-3054210	REB INJECTOR,PTD DFF	C-PTD
R-3054211	REB INJECTOR,PTD DFF	C-PTD
R-3054213	REB INJECTOR,PTD DFF	C-PTD
R-3054216	REB INJECTOR,PTD DFF	C-PTD
R-3054217	REB INJECTOR,PTD DFF	C-PTD
R-3054218	REB INJECTOR,PTD DFF	C-PTD
R-3054219	REB INJECTOR,PTD DFF	C-PTD
R-3054220	REB INJECTOR,PTD DFF	C-PTD
R-3054221	REB INJECTOR,T/S DFF	C-T/S
R-3054222	REB INJECTOR,T/S DFF	C-T/S
R-3054223	REB INJECTOR,T/S DFF	C-T/S
R-3054224	REB INJECTOR,T/S DFF	C-T/S
R-3054225	REB INJECTOR,T/S DFF	C-T/S
R-3054226	REB INJECTOR,T/S DFF	C-T/S
R-3054227	REB INJECTOR,T/S DFF	C-T/S
R-3054228	REB INJECTOR,T/S DFF	C-T/S
R-3054229	REB INJECTOR,T/S DFF	C-T/S
R-3054230	REB INJECTOR,T/S DFF	C-T/S
R-3054231	REB INJECTOR,T/S DFF	C-T/S
R-3054232	REB INJECTOR,T/S DFF	C-T/S
R-3054233	REB INJECTOR,T/S DFF	C-T/S

Product No.	Description	Core Code
R-3054234	REB INJECTOR,T/S DFF	C-T/S
R-3054235	REB INJECTOR,T/S DFF	C-T/S
R-3054236	REB INJECTOR,T/S DFF	C-T/S
R-3054238	REB INJECTOR,PTD DFF	C-PTD
R-3054240	REB INJECTOR,PTD DFF	C-PTD
R-3054242	REB INJECTOR,PTD DFF	C-PTD
R-3054246	REB INJECTOR,PTD DFF	C-36B
R-3054247	REB INJECTOR,PTD DFF	C-PTD
R-3054248	REB INJECTOR,PTD DFF	C-PTD
R-3054249	REB INJECTOR,PTD DFF	C-PTD
R-3054250	REB INJECTOR,PTD DFF	C-PTD
R-3054251	REB INJECTOR,PTD DFF	C-PTD
R-3054254	REB INJECTOR,PTD DFF	C-PTD
R-3054255	REB INJECTOR,PTD DFF	C-PTD
R-3056342	REB INJECTOR,L10,T/S DFF	C-36B
R-3058849	REB INJECTOR,PTD	C-PTD
R-3059424	REB INJECTOR,T/S DFF	C-T/S
R-3062535	REB INJECTOR,PTD DFF	C-PTD
R-3064253	REB INJECTOR,T/S DFF	C-T/S
R-3066486	REB INJECTOR,L10,T/S DFF	C-36B
R-3066487	REB INJECTOR,L10,T/S DFF	C-36B
R-3069759	REB INJECTOR,L10,T/S DFF	C-36B
R-3069767	REB INJECTOR,T/S DFF	C-T/S
R-3071047	REB INJECTOR,T/S DFF	C-T/S
R-3081277	REB INJECTOR,L10,T/S DFF	C-36B
R-3084108	REB INJECTOR,T/S DFF	C-T/S
R-3084398	REB INJECTOR,L10,T/S DFF	C-36B
R-3275273	REB INJECTOR,PTD 5/16'	C-30B
R-3275274	REB INJECTOR,PTD 5/16'	C-30B
R-3275275	REB INJECTOR,PTD 5/16'	C-30B
R-3275537	REB INJECTOR,PTD 5/16'	C-30B
R-3275538	REB INJECTOR,PTD 5/16'	C-30B
R-3275539	REB INJECTOR,PTD 5/16'	C-30B
R-3275720	REB INJECTOR,PTD 5/16'	C-30B
R-3275989	REB INJECTOR,PTD 5/16'	C-30B
R-3275990	REB INJECTOR,PTD 5/16'	C-30B
R-3275991	REB INJECTOR,PTD 5/16'	C-30B
R-3275992	REB INJECTOR,PTD 5/16'	C-30B



INTERSTATE-McBEE



© Cummins and Cummins CELECT are registered trademarks of Cummins, Inc.

All manufacturer's names, numbers, symbols and descriptions are used for reference purposes only and does not imply that any part listed is the product of these manufacturers.

Cummins® Core Codes

Product No.	Description	Core Code
R-3277453	REB INJECTOR,PTD 5/16'	C-30B
R-3277470	REB INJECTOR,PTD 5/16'	C-30B
R-3277471	REB INJECTOR,PTD 5/16'	C-30B
R-3277763	REB INJECTOR,PTD 5/16'	C-30B
R-3279505	REB INJECTOR,L10,T/S DFF	C-36B
R-3279636	REB INJECTOR,L10,T/S DFF	C-36B
R-3279661	REB INJECTOR,PTD DFF	C-PTD
R-3279664	REB INJECTOR,PTD DFF	C-PTD
R-3279801	REB INJECTOR,T/S DFF	C-T/S
R-AR40031	REB INJECTOR,PTD	C-PTD
R-AR40035	REB INJECTOR,PTD	C-PTD
R-AR40117	REB INJECTOR,PTD	C-PTD
R-AR40118	REB INJECTOR,PTD	C-PTD
R-AR40125	REB INJECTOR,PTD	C-PTD
R-AR40173	REB INJECTOR,PTD	C-PTD
R-AR40221	REB INJECTOR,PTD	C-PTD
R-AR40239	REB INJECTOR,PTD	C-PTD
R-AR51217	REB INJECTOR,PTD	C-PTD
R-AR73626	REB INJECTOR,PTD 5/16'	C-30B

Cummins® Celect



Core Code	Part Number				
C-CELECT1	R-3073995	R-3652541	R-3011314		
	R-3081315	R-3652542	R-3070739		
C-CELECT2	R-3084589	R-3095040	R-3411754	R-4026222	
	R-3087557	R-3166395	R-3411756	R-4061851	
	R-3087734	R-3411752	R-3411758	R-3411755	
	R-3087772	R-3411753	R-3609922		
C-CELECT3	R-3083846	R-3087788	R-3409975	R-3411757	R-3411764
	R-3083848	R-3087807	R-3411381	R-3411760	R-3411765
	R-3087556	R-3088178	R-3411385	R-3411761	R-3411766
	R-3087558	R-3085086	R-3411691	R-3411762	R-3411767
	R-3087560	R-3086662	R-3411759	R-3411763	R-3609796
	R-3087733	R-4061851	R-4902921	R-4900295	

© Cummins and Cummins CELECT are registered trademarks of Cummins, Inc.





All manufacturer's names, numbers, symbols and descriptions are used for reference purposes only and does not imply that any part listed is the product of these manufacturers.



INTERSTATE-McBEE



Cummins® Celect

<p>C-CELECT1</p>	<p>Wide/Solid (3/8") Spacer</p>	
<p>C-CELECT2</p>	<p>No Spacer Bolt Different angle of body for stator</p>	
<p>C-CELECT3</p>	<p>1/4" Spacer Spacer is solid or cupped</p> 	

IMPORTANT REMINDER: WE DO NOT ACCEPT L10 CORES SUCH AS PART NO. 3652540
 While these injectors look similar, they are not the same and cannot be credited.
 See image below for clarification.



INTERSTATE-McBEE



© Cummins and Cummins CELECT are registered trademarks of Cummins, Inc.
 All manufacturer's names, numbers, symbols and descriptions are used for reference purposes only and does not imply that any part listed is the product of these manufacturers.

ISX are Like for Like Part Number + Link + Matching Nozzle Number

The nozzles should have a part number legible like the image below.



Some nozzles may have a QR code, which is acceptable.



The following characteristics are found in a good take-out core:

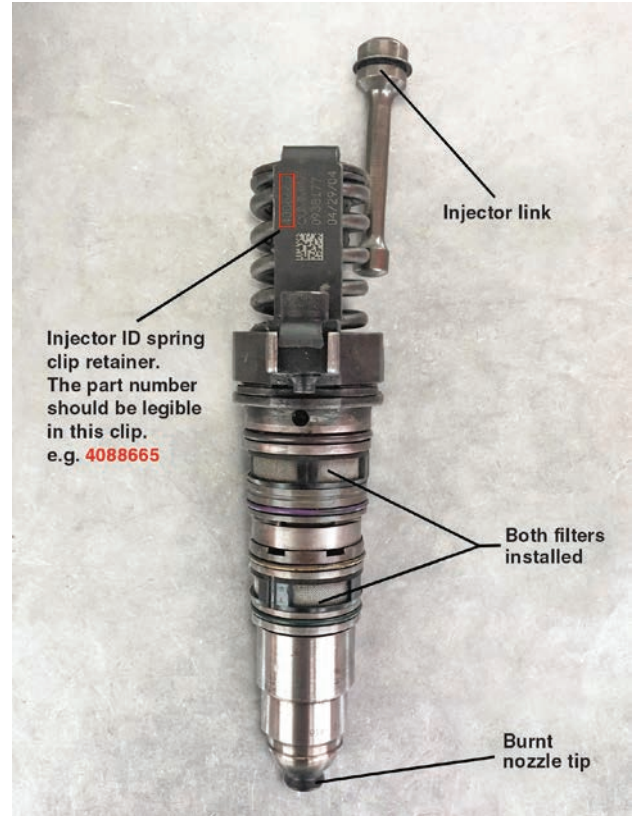

Identifying Fake and Genuine Nozzles



Damaged / Broken ISX Nozzles (Tips) Will NOT Be Accepted

The table below shows the matching nozzle numbers with the injector part number:

Old Part Number	Injector Part Number	Core Code	Additional Requirement	Correct Matching Nozzle Number
4010225	R-4062567	C-4062567	Core Link	3348357
4001791, 4010291	R-4062568	C-4062568	Core Link	4088648, 3331242
	R-4062569	C-4062569	Core Link	4088652
	R-4088301	C-4088301	Core Link	4088303, 4088658
	R-4088327	C-4088327	Core Link	4088660, 4088727, 4088328, 4088329, 4088566
	R-4088665	C-4088665	Core Link	4088662
	R-4954434	C-4954434	Core Link	4954432
	R-4954888	C-4954888	Core Link	4954886, 4954487, 4018827



INTERSTATE-McBEE



ISX Spring Retainers

Cummins ISX injectors are compatible with either of two injector load rings. The load ring located at the top of the injector body (see photos below) includes the spring retainer and is not injector part number specific. Both style load rings are made to fit all applications and are interchangeable within a single engine. Running an engine with one or the other or both styles will cause no loss in performance or any adverse effect. For additional information, refer to Cummins Technical Bulletin TSB100685 dated 23-May-2008.

Type A: Two-Piece, Bolted Retainer





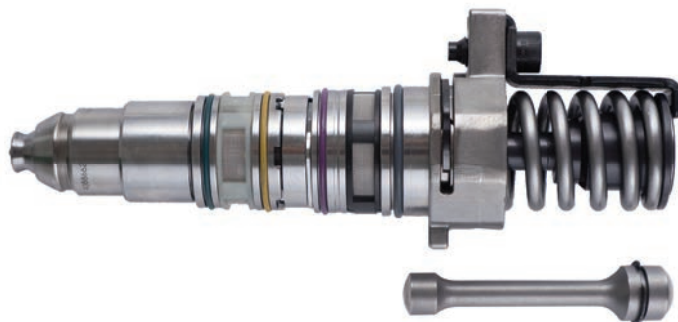

Type B: One-Piece, Spring Retainer



INTERSTATE-McBEE

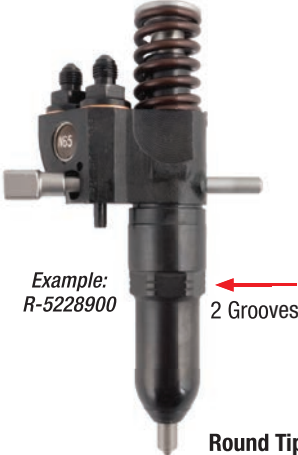

Detroit Diesel® 53/71/92/8.2

C-NC9	C-71S	C-71H	C-82
 <p>Example: R-5228900 ← 2 Grooves</p> <p>Round Tip</p>	 <p>Example: R-5228580 ← Groove</p> <p>Pointed Tip</p>	 <p>Example: R-5228305 ← Groove</p> <p>Pointed Tip</p>	 <p>Example: R-5226270</p> 
<p>This is a standard Detroit, N, C, 53, 71, 92 Series injector style. Please note that the nut on the NC9 has two smaller grooves.</p>	<p>This is a Detroit S injector core. Note that the body is similar to the C-NC9 core, but the nut on the S core has one large groove.</p>	<p>This is a Detroit HV core. The body is different than an NC9, and the nut has one large groove.</p>	<p>This is a Detroit 8.2L injector core. The 8.2L cores look the same, but the difference can be found by the letter stamped into the body clamp.</p>
C-71C		C-149	
 <p>Example: R-5228781 ← 2 Grooves</p> <p>Round Tip</p>	 <div style="display: flex; justify-content: space-around; align-items: center;"> <div style="text-align: center;"> <p>Pointed Tip</p>  </div> <div style="text-align: center;"> <p>Round Tip</p>  </div> </div>		
<p>This is a Detroit HN core. The body is different than an NC9, and the nut has two grooves.</p>			

NOTE: Tip may be broken, but never missing.



Detroit Diesel® Pumps & Exceptions

LV injectors have a 2 piece follower and are NOT acceptable.



Marine style filter caps have no threads. Cores sent for injectors ordered with Marine caps must also have Marine caps.



Part No.	Description	Core Code
R-5199560	Fuel Pump - LH - 1/4	C-L00
R-5199561	Fuel Pump - RH - 1/4	C-L0Z
R-5199734	Fuel Pump - RH - 3/8 - Hi-Cap	C-L01
R-5199735	Fuel Pump - LH - 3/8 - Hi-Cap	C-L02
R-23532981	Fuel Pump - S60	C-L60

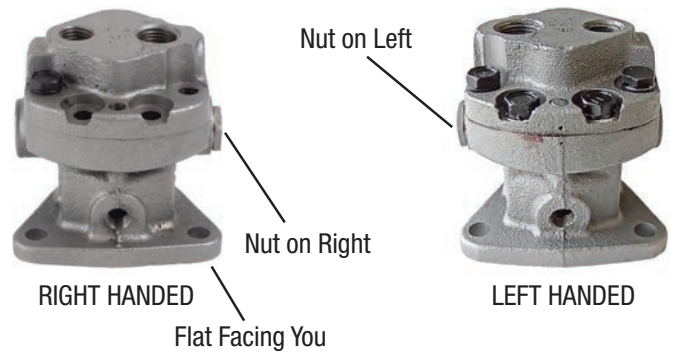

S60

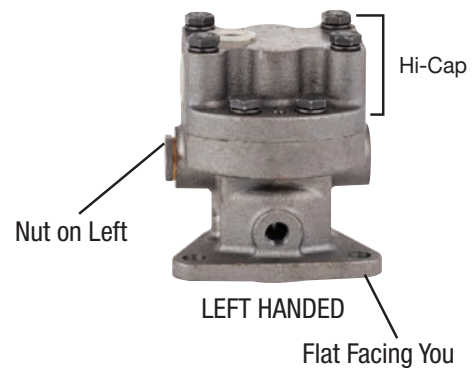

Detroit Diesel® Core Codes

Product No.	Description	Core Code
R-5199560	PUMP-FUEL REMAN LH	C-L0Z
R-5199561	PUMP-FUEL REMAN RH	C-L00
R-5226055	4B45 INJECTOR,8.2L	C-82
R-5226075	5N45 INJECTOR	C-NC9
R-5226085	9F85 INJECTOR,92	C-NC9
R-5226090	9F90 INJECTOR,92	C-NC9
R-5226110	4A70 INJECTOR,8.2L	C-82
R-5226125	160M INJECTOR,149	C-149
R-5226130	190 INJECTOR,149	C-149
R-5226135	9S70 INJECTOR	C-NC9
R-5226145	7S75 INJECTOR	C-NC9
R-5226155	7S70 INJECTOR	C-NC9
R-5226165	9S65 INJECTOR	C-NC9
R-5226170	7S65 INJECTOR	C-NC9
R-5226175	4B55 INJECTOR,8.2L	C-82
R-5226180	4E67 INJECTOR,8.2L	C-82
R-5226215	9E85 INJECTOR	C-NC9
R-5226225	9E80 INJECTOR	C-NC9
R-5226230	5C60 INJECTOR,53	C-NC9
R-5226235	5E60 INJECTOR	C-NC9
R-5226240	5C55 INJECTOR	C-NC9
R-5226245	5E55 INJECTOR	C-NC9
R-5226250	5C50 INJECTOR	C-NC9
R-5226260	4H60 INJECTOR,8.2L	C-82
R-5226270	4B75 INJECTOR,8.2L	C-82
R-5226280	5E50 INJECTOR	C-NC9
R-5226345	9G95 INJECTOR	C-NC9
R-5226405	9H85 INJECTOR	C-NC9
R-5226410	9G90 INJECTOR,92	C-NC9
R-5226420	9G85 INJECTOR,92	C-NC9
R-5226425	9G75 INJECTOR	C-NC9
R-5226440	7N65 INJECTOR,71	C-NC9
R-5226475	9F70 INJECTOR	C-NC9
R-5226495	9F80 INJECTOR,92	C-NC9
R-5226505	9S75 INJECTOR	C-NC9
R-5226510	9T70 INJECTOR	C-NC9
R-5226515	9S80 INJECTOR	C-NC9
R-5226520	149-240 INJECTOR	C-149
R-5226525	9E95 INJECTOR	C-NC9
R-5226555	145 INJECTOR,92	C-NC9
R-5226575	9A31 INJECTOR	C-NC9
R-5226595	7A77 INJECTOR	C-NC9
R-5226635	9J85 INJECTOR,92	C-NC9
R-5226670	9K85 INJECTOR	C-NC9
R-5226675	9A98 INJECTOR	C-NC9
R-5226695	4T80 INJECTOR,8.2L	C-82
R-5226725	149-230 INJECTOR	C-149
R-5226755	149-145M INJECTOR	C-149
R-5226795	M15 INJECTOR	C-NC9

Product No.	Description	Core Code
R-5226810	149-6810 INJECTOR	C-149
R-5226815	6815 INJECTOR	C-NC9
R-5226840	6840 INJECTOR	C-NC9
R-5226850	6850 INJECTOR	C-NC9
R-5226880	4C59 INJECTOR,8.2L	C-82
R-5226885	4C45 INJECTOR,8.2L	C-82
R-5226890	4C40 INJECTOR,8.2L	C-82
R-5226900	4R80 INJECTOR,8.2L	C-82
R-5226960	4T75 INJECTOR,8.2L	C-82
R-5226965	4T70 INJECTOR,8.2L	C-82
R-5227005	7005 INJECTOR	C-NC9
R-5227015	7015 INJECTOR	C-NC9
R-5227020	75N INJECTOR	C-NC9
R-5227025	7025 INJECTOR	C-NC9
R-5227030	7030 INJECTOR	C-NC9
R-5227035	7035 INJECTOR	C-NC9
R-5227040	7040 INJECTOR	C-NC9
R-5227045	7045 INJECTOR	C-NC9
R-5227105	7105 INJECTOR	C-NC9
R-5227125	7125 INJECTOR	C-NC9
R-5227145	7145 INJECTOR,149	C-149
R-5227175	7175 INJECTOR,149	C-149
R-5227180	7180 INJECTOR,149	C-149
R-5227185	7185 INJECTOR,149	C-149
R-5227190	7190-149 Injector, Marine	C-149
R-5227245	7245 INJECTOR	C-NC9
R-5227255	7255 INJECTOR	C-NC9
R-5227270	149-270 INJECTOR	C-149
R-5227425	7425 INJECTOR,92	C-NC9
R-5227495	7495 INJECTOR	C-NC9
R-5227570	7570 INJECTOR ,92	C-NC9
R-5228110	HV8 INJECTOR,71	C-71H
R-5228300	HV55 INJECTOR,71	C-71H
R-5228305	HV7 INJECTOR,71	C-71H
R-5228310	HV6 INJECTOR,71	C-71H
R-5228375	6E8 INJECTOR	C-71H
R-5228380	HV9 INJECTOR,71	C-71H
R-5228445	6S8 INJECTOR	C-71S
R-5228465	HV9-OFFSET INJECTOR, HI CRAB E	C-71H
R-5228470	HV7/S BODY INJECTOR	C-71S
R-5228521	S55 INJECTOR	C-71S
R-5228522	S 60 INJECTOR	C-71S
R-5228523	S70 INJECTOR	C-71S
R-5228524	S80 INJECTOR	C-71S
R-5228525	S90 INJECTOR	C-71S
R-5228535	S35 INJECTOR	C-71S
R-5228550	S50 INJECTOR	C-71S
R-5228580	S45 INJECTOR,53	C-71S
R-5228590	S40 INJECTOR,53	C-71S
R-5228760	N60 INJECTOR,71	C-NC9





Detroit Diesel® Core Codes

Product No.	Description	Core Code
R-5228763	N40 INJECTOR,53	C-NC9
R-5228765	N65 INJECTOR,71	C-NC9
R-5228770	N70 INJECTOR,71	C-NC9
R-5228773	N45 INJECTOR,53	C-NC9
R-5228777	N75 INJECTOR,71	C-NC9
R-5228780	N80 INJECTOR,71	C-NC9
R-5228783	N50 INJECTOR,53	C-NC9
R-5228785	N55 INJECTOR,53	C-NC9
R-5228790	N90 INJECTOR,53/71	C-NC9
R-5228793	L40 INJECTOR	C-NC9
R-5228795	M95 INJECTOR,71	C-NC9
R-5228814	M65 INJECTOR	C-NC9
R-5228824	M60 INJECTOR	C-NC9
R-5228834	M55 INJECTOR	C-NC9
R-5228850	71N5 INJECTOR,71	C-NC9
R-5228900	N65 INJECTOR,BROWN TAG,71	C-NC9
R-5229170	9270 INJECTOR,92	C-NC9
R-5229180	9280 INJECTOR,92	C-NC9
R-5229185	M70 INJECTOR	C-NC9
R-5229206	HN60 INJECTOR	C-71C
R-5229207	HN70 INJECTOR	C-71C
R-5229208	HN80 INJECTOR	C-71C
R-5229209	HN35 INJECTOR	C-71C
R-5229210	HN40 INJECTOR	C-71C
R-5229211	HN45 INJECTOR	C-71C
R-5229212	HN50 INJECTOR	C-71C
R-5229214	HN55 INJECTOR	C-71C
R-5229216	HN65BT INJECTOR	C-71C
R-5229218	HN75 INJECTOR	C-71C
R-5229225	R60 INJECTOR	C-NC9
R-5229340	C40 INJECTOR,53	C-NC9
R-5229345	C45 INJECTOR,53	C-NC9
R-5229350	C50 INJECTOR,53	C-NC9
R-5229352	71C5 INJECTOR,71	C-NC9
R-5229355	C55 INJECTOR,71	C-NC9
R-5229360	C60 INJECTOR,71	C-NC9
R-5229365	C65 INJECTOR,71	C-NC9
R-5229370	C70 INJECTOR,71	C-NC9
R-5229380	9275 INJECTOR,92	C-NC9
R-5229385	HC60 INJECTOR	C-71C
R-5229388	HC55 INJECTOR	C-71C
R-5229389	HC65 INJECTOR	C-71C
R-5229395	9295 INJECTOR,92	C-NC9
R-5229400	9285 INJECTOR,92	C-NC9
R-5229405	9290 INJECTOR,92	C-NC9
R-5229410	9200 INJECTOR,92	C-NC9
R-5229495	N140 INJECTOR	C-NC9
R-5229595	N35 INJECTOR,53	C-NC9
R-5229610	M40 INJECTOR	C-NC9
R-5229620	9A80 INJECTOR,92	C-NC9
R-5229625	9A85 INJECTOR,92	C-NC9

Product No.	Description	Core Code
R-5229630	9A90 INJECTOR,92	C-NC9
R-5229635	120 INJECTOR,149	C-149
R-5229640	130 INJECTOR,149	C-149
R-5229645	140 INJECTOR,149	C-149
R-5229650	150 INJECTOR,149	C-149
R-5229655	165 INJECTOR,149	C-149
R-5229660	180 INJECTOR,149	C-149
R-5229665	7A65 INJECTOR	C-NC9
R-5229666	5A60 INJECTOR,53	C-NC9
R-5229670	7A70 INJECTOR,71	C-NC9
R-5229675	7A75 INJECTOR,71	C-NC9
R-5229676	5A55 INJECTOR,53	C-NC9
R-5229680	7A60 INJECTOR,71	C-NC9
R-5229685	7A55 INJECTOR,71	C-NC9
R-5229690	7A50 INJECTOR,71	C-NC9
R-5229695	7C75 INJECTOR,71	C-NC9
R-5229700	7C70 INJECTOR,71	C-NC9
R-5229715	9215 INJECTOR,92	C-NC9
R-5229785	7E50 INJECTOR,71	C-NC9
R-5229790	7E55 INJECTOR,71	C-NC9
R-5229795	7E60 INJECTOR,71	C-NC9
R-5229800	7E65 INJECTOR,71	C-NC9
R-5229805	9B80 INJECTOR,92	C-NC9
R-5229810	9B90 INJECTOR,92	C-NC9
R-5229815	9B85 INJECTOR,92	C-NC9
R-5229820	7E75 INJECTOR,71	C-NC9
R-5229825	5N65 INJECTOR	C-NC9
R-5229830	149-195 INJECTOR	C-149
R-5229845	9225 INJECTOR	C-NC9
R-5229850	4A53 INJECTOR,8.2L	C-82
R-5229855	9B70 INJECTOR,92	C-NC9
R-5229860	9B75 INJECTOR,92	C-NC9
R-5229870	9C70 INJECTOR,92	C-NC9
R-5229875	9C75 INJECTOR,92	C-NC9
R-5229885	9C85 INJECTOR,92	C-NC9
R-5229890	9C90 INJECTOR,92	C-NC9
R-5229895	7G65 INJECTOR,71,92	C-NC9
R-5229900	7G70 INJECTOR,71,92	C-NC9
R-5229905	7G75 INJECTOR,71,92	C-NC9
R-5229910	170 INJECTOR,149	C-149
R-5229915	4C65 INJECTOR,8.2L	C-82
R-5229920	5A50 INJECTOR,53	C-NC9
R-5229955	9D95 INJECTOR	C-NC9
R-5229960	4A40 INJECTOR,8.2L	C-82
R-5229970	9E65 INJECTOR,92	C-NC9
R-5229975	9E70 INJECTOR,92	C-NC9
R-5229985	9210 INJECTOR	C-NC9
R-5229995	7N95 INJECTOR	C-NC9
R-5235670	5670 INJECTOR	C-NC9
R-5235905	5905 INJECTOR	C-NC9

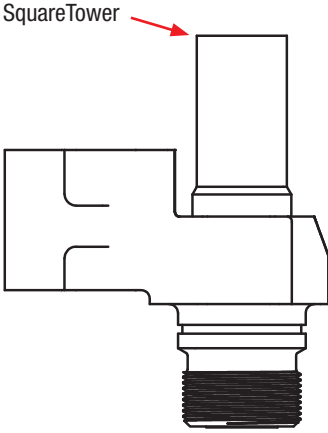
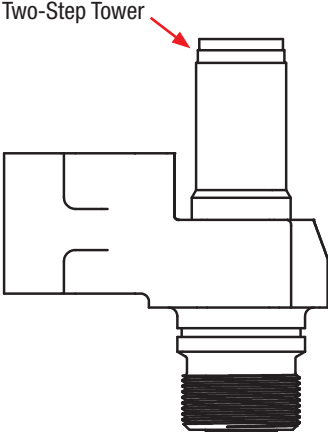
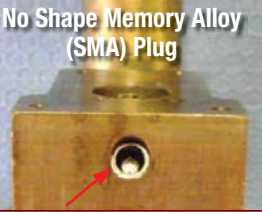
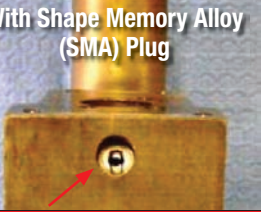
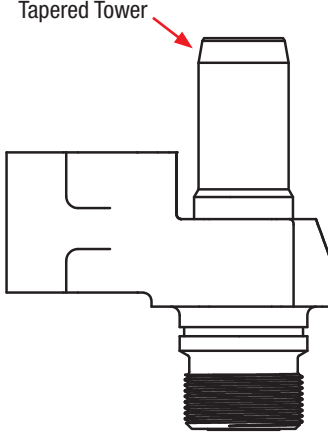
© Detroit Diesel is a registered trademark of Detroit Diesel Corporation. All manufacturer's names, numbers, symbols and descriptions are used for reference purposes only and does not imply that any part listed is the product of these manufacturers.

Detroit Diesel® Series S60

Not Acceptable: Type I	Acceptable: Type II	Acceptable: Type III	Acceptable: Type IV
<p>Square Tower</p> 	<p>Two-Step Tower</p> 	<p>No Shape Memory Alloy (SMA) Plug</p> 	<p>With Shape Memory Alloy (SMA) Plug</p> 
		<p>Braze Plug (No Slot)</p>	<p>SMA Plug (Slotted)</p>
		<p>Tapered Tower</p> 	
			
<p>Square Tower</p>	<p>Stepped Tower</p>	<p>Tapered Tower</p>	



BROKEN SCREW
This is Not Acceptable



C-S60DDEC2, C-S60DDEC3/4
Each core can be identified by the tower of the body, underneath the spring. The C-S60DDEC2 core has two distinct steps and the C-S60DDEC3/4 has a tapered tower.



INTERSTATE-McBEE



© Detroit Diesel is a registered trademarks of Detroit Diesel Corporation.
All manufacturer's names, numbers, symbols and descriptions are used for reference purposes only and does not imply that any part listed is the product of these manufacturers.

Detroit Diesel® Series S60 / DD13/15/16

Series 60

Product No.	Description	Core Code	
R-5234785	REBUILT INJECTOR, S6011.1L & 12.7L	C-S60DDEC1	
R-5234795	REBUILT INJECTOR, S60 12.7L	C-S60DDEC2	
R-5234865	REBUILT INJECTOR, S60 11.1L		
R-5234870	REBUILT INJECTOR, S60 11.1L		
R-5234935	REBUILT INJECTOR, S60 11.1L		
R-5234940	REBUILT INJECTOR, S6011.1L & 12.7L		
R-5234945	REBUILT INJECTOR, S60 12.7L		
R-5234970	REBUILT INJECTOR,S60		
R-5235550	REBUILT INJECTOR, S50/60(8.5L S50)		C-S60DDEC3/4
R-5235575	REBUILT INJECTOR, S50/60(12.7L S60)		
R-5235580	REBUILT INJECTOR, S60 11.1L		
R-5235600	REBUILT INJECTOR, S50/60(8.5L S50)		
R-5235605	REBUILT INJECTOR,S60		
R-5235695	REBUILT INJECTOR,S60		
R-5235915	REBUILT INJECTOR,S50/60		
R-5236347	REBUILT INJECTOR,S50		
R-5236977	REBUILT INJECTOR,S50/60		
R-5236978	REBUILT INJECTOR,S50/60		
R-5236980	REBUILT INJECTOR,S60	C-S6014L	
R-5236981	REBUILT INJECTOR,S50		
R-5237042	REBUILT INJECTOR,S60		
R-5237045	REBUILT INJECTOR,S60		
R-5237099	REBUILT INJECTOR,S60		
R-5237466	REBUILT INJECTOR,S60		
R-5237650	REBUILT INJECTOR,S60		
R-5237787	REBUILT INJECTOR,S50/60		
R-414703002	S60 - 14L - Injector - Reman	C-S6014L	
R-414703003	S60 - 14L - Injector - Reman		
R-414703005	S60 - 14L - Injector - Reman		
R-414703007	S60 - 14L - Injector - Reman		

DD13/15/16

McBee Part No.	Description	Detroit Diesel Part No.	Bosch Part No.	Core Code
R-0986435539	DD15/16 Injector - Remanufactured	4710700387	0445120194	C-DD15
		4710700287		
		4710700187		
R-0986435642	DD13 Injector - Remanufactured	4460700587	0445120207	C-DD13
		4600701087	0445120104	
		4600701187	0455120303	
		4720700587	0986435540	
		4720700887		

DD13/15/16 Reman Injector



Series 60, DDEC Reman Injector



Series 60, 14L Reman Injector



© Detroit Diesel is a registered trademarks of Detroit Diesel Corporation.
All manufacturer's names, numbers, symbols and descriptions are used for reference purposes only and does not imply that any part listed is the product of these manufacturers.



INTERSTATE-McBEE



NOTE: As of February 2020, all new ALLIANT injector sales require a LIKE-for-LIKE core to be returned.

On the TOP of the injector, look for the TWO LETTERS at the beginning (or end) of the injector part number. These two letters will identify the injector code. These injectors are both “BN”:

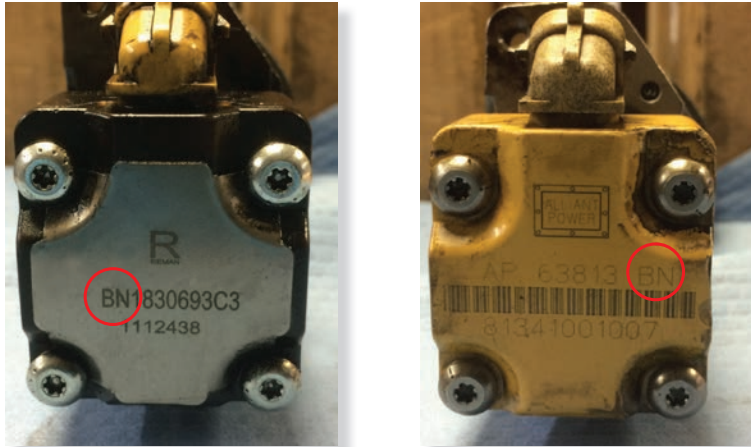

If there aren't two letters at the beginning or end matching a core code, the following are the OEM original injector part numbers and their respective core code:

Injector Code	Core Code
BD	C-466E-BD
BE	C-466E-BE
BF	C-466E-BFP
BG	C-466E-BFP
BI	C-466E-BFP
BJ	C-466E-BFP
BN	C-466E-BFP
BP	C-466E-BFP

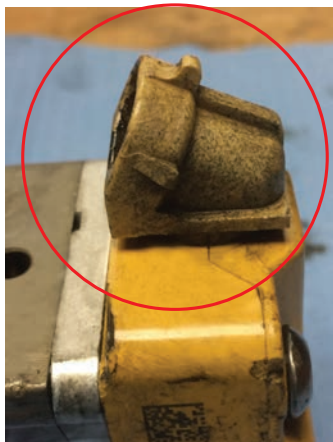

The connector at the top of the injector must be intact. If it is broken or chipped the core is NOT ACCEPTABLE. The picture above is an acceptable connector.



*Part Number
Location*

Acceptable

- No electrical burn marks on plastic solenoid over mold (yellow plastic with dot matrix)
- Readable bar code or part # on the solenoid over mold
- Readable part # and serial # on the red/blue solenoid coil
- Bolts must be present and secure
- All 4 wires are intact, small “nicks” are acceptable
- Plastic connector is present, damage to plastic & bent pins are acceptable
- No damage to the nozzle



Reference	Interstate-McBee Part No.	Core Code	Application	PP Reference
5010656R92 1842576C91-94 AP66976 6922-PP	R-5010656R92	C-4247	DT466 Engines MY2004-MY2005.5 Low HP	4L
5010657R92 1842577C92-94 AP66977 6923-PP	R-5010657R92	C-4248	DT466 Engines MY2004-MY2005.5 High HP	4H
5010658R92 1842578C91-95 AP66978 6924-PP	R-5010658R92	C-4249	DT570 Engines MY2004-MY2005.5 Low HP	5L
5010659R92 1842579C91-95 AP66979 6925-PP	R-5010659R92	C-4250	DT570 Engines MY2004-MY2005.5 High HP	5H
5010983R91 1848489C91-92 AP66989 6926-PP	R-5010983R91	C-8489	DT466 Engines MY2005.5-MY2007 ALL HP	4HB
5010984R91 1848492C91-92 AP66992 6927-PP	R-5010984R91	C-8492	DT570 Engines MY2005.5-MY2007 Low HP	5LB
5010985R91 1848495C91-92 AP66995 6928-PP	R-5010985R91	C-8495	DT466 Engines MY2005.5-MY2007 High HP	5HB
5010561R91 1848718C91-94 AP66918 6929-PP	R-5010561R91	C-0561	MaxxForce DT MY2007-MY2010	4C
5010823R91 1848721C91-94 AP66821 6930-PP 4307212R91	R-5010823R91	C-0823	MaxxForce 9 MY2007-MY2010	5C
5010986R91 1884057C91-92 AP66857 6931-PP	R-5010986R91	C-4057	MaxxForce DT MY2009-MY2010	4F
5010715R91 1890055C91-92 AP66955 6932-PP	R-5010715R91	C-0715	MaxxForce DT MY2010-	4HG
5010717R91 1890057C91-92 AP66858 6933-PP	R-5010717R91	C-0717	MaxxForce 10 MY2010-	5G

Cores will be accepted for any of the exchange injectors within the same core code classification.



INTERSTATE-McBEE

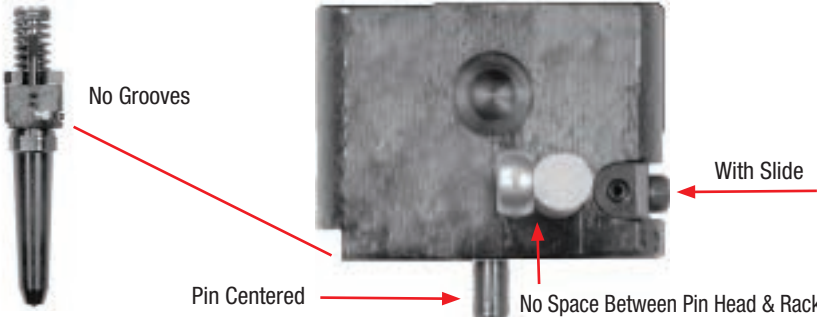
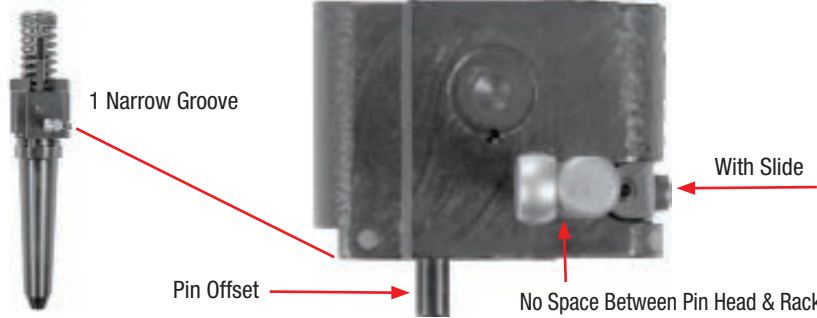
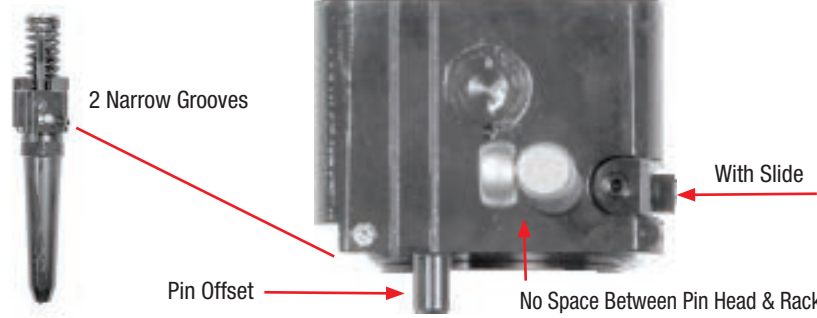
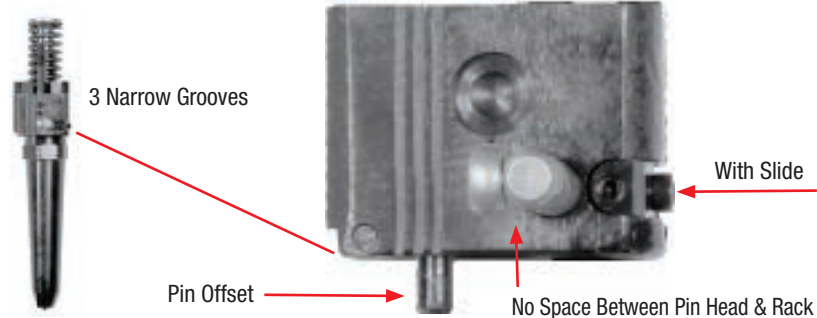

© Navistar is a registered trademark of Navistar, Inc.
All manufacturer's names, numbers, symbols and descriptions are used for reference purposes only and does not imply that any part listed is the product of these manufacturers.

Core No. / Body Description	Injector Part Numbers
<p>C-EMDNO No Grooves, With Slide</p> 	<p>5229295, 5229500, 8478049, 9081163, 40078996, 40079003, 40083527, 40083534, 40084722, 40084726, 40129258</p>
<p>C-EMD1N 1 Narrow Groove With Slide</p> 	<p>5229200, 5229290, 5229510, 8478045, 8478048, 9081164, 40078993, 40078995, 40079004, 40083524, 40083526, 40083535, 40084719, 40084721, 40084727, 40100567, 40100740, 40187254UX</p>
<p>C-EMD2N 2 Narrow Grooves With Slide</p> 	<p>5229305, 5229310, 8478050, 8478051, 40078997, 40078998, 40083528, 40083529</p>
<p>C-EMD3N 3 Narrow Grooves With Slide</p> 	<p>5229250, 5229315, 8478046, 8478052, 40078994, 40078999, 40084720, 40100568, 40100741</p> <p><i>Note: This core can be converted into an EMD1W or EMD2W for an additional charge</i></p>



INTERSTATE-McBEE

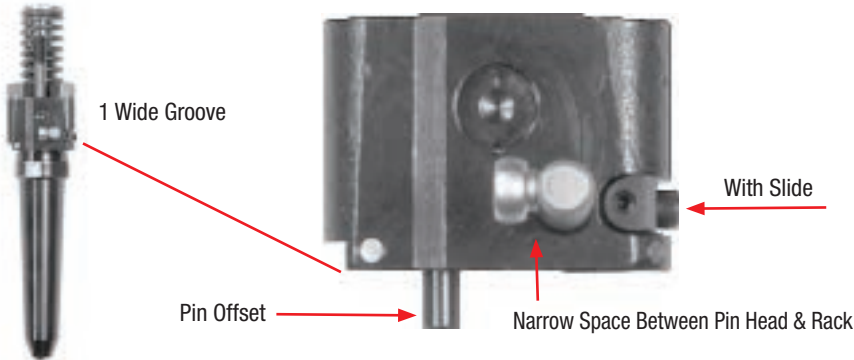
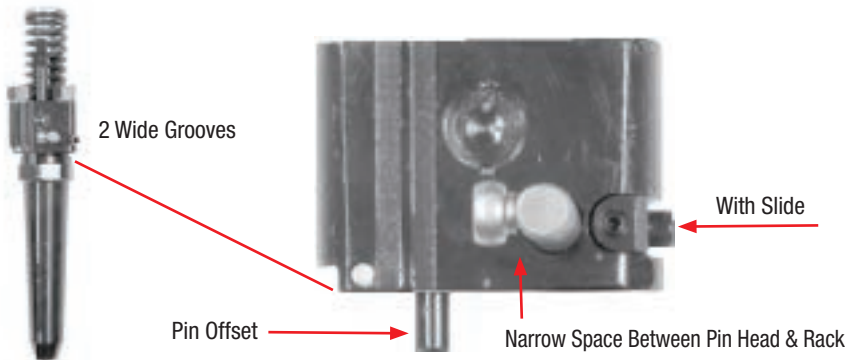
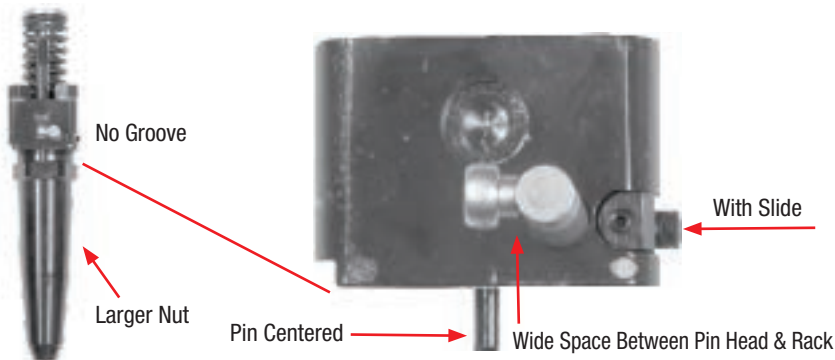

Core No. / Body Description	Injector Part Numbers
<p>C-EMD1W 1 Wide Groove, With Slide</p> 	<p>4991017, 5229320, 5229325, 5229335, 8478053, 8478054, 8478055, 40079000, 40079001, 40079002, 40083531, 40083532, 40083533, 40084723, 40084724, 40084725, 40100569, 40100742, 40187255UX</p> <p><i>Note: This core can be converted into an EMD2W for an additional charge</i></p>
<p>C-EMD2W 2 Wide Grooves, With Slide</p> 	<p>5226150, 5226210, 5226430, 5226470, 5226775, 5226785, 5229710, 5235585, 5236671, 9333858, 9561950, 9576569, 40043489, 40078986, 40078987, 40078988, 40078990, 40079005, 40079006, 40079009, 40080872, 40083516, 40083518, 40083519, 40083520, 40083523, 40083536, 40083539, 40084713, 40084714, 40084715, 40084718, 40084728, 40084731, 40098027, 40099335, 40100501, 40100570, 40100743</p>
<p>C-EMD710 No Groove, With Slide</p> 	<p>5226700, 5227000, 5227285, 5235595, 9565086, 40027607, 40028663, 40044488, 40077234, 40077235, 40078991, 40079007, 40083521, 40083537, 40083538, 40083540, 40084717, 40084729, 40084730, 40084732, 40095069, 40103324, 40111736, 40112504</p>



INTERSTATE-McBEE



Unacceptable Mechanical Injector Cores

* Except for conversions as noted.

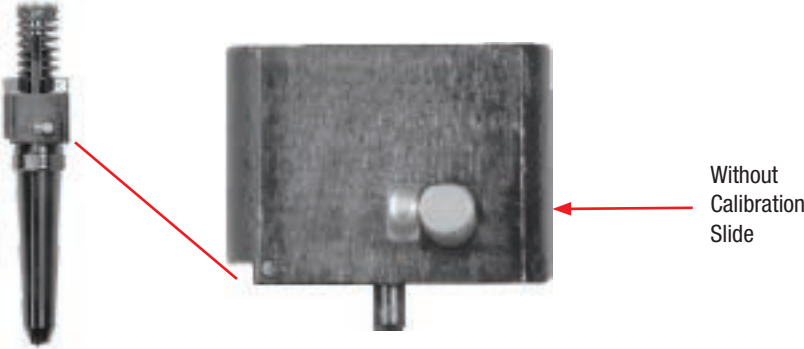
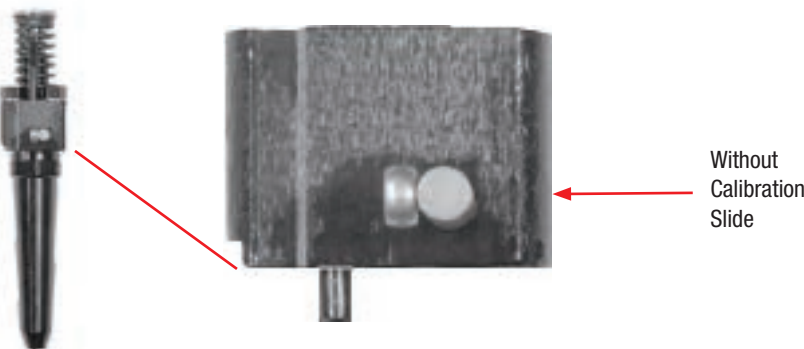
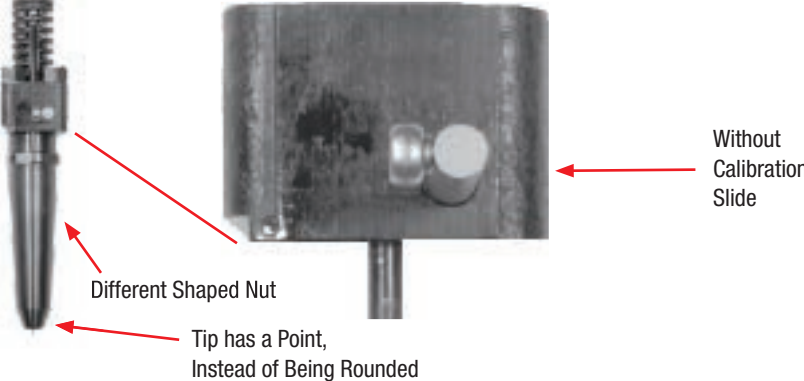
Core No. / Body Description	Injector Part Numbers
<p>C-E8565 No Groove, Without Slide</p>  <p>Without Calibration Slide</p>	5228565
<p>C-E8540 1 Narrow Groove, Without Slide</p>  <p>Without Calibration Slide</p>	5228540
<p>Cleveland Diesel / Spherical Valve No Groove, Without Slide</p>  <p>Different Shaped Nut</p> <p>Tip has a Point, Instead of Being Rounded</p> <p>Without Calibration Slide</p>	5228190, 5227326



INTERSTATE-McBEE



EMD Racks

	<p>No Line 1 Narrow 2 Narrow</p> <p>No gap between pin and rack.</p> <p>Groove around rack</p>
	<p>3 Narrow</p> <p>No gap between pin and rack.</p> <p>Groove at end of rack</p>
	<p>Any Wide</p> <p>Gap between pin and rack</p> <p>Multiple grooves in rack</p>
	<p>710</p> <p>Large Gap between pin and rack</p> <p>Groove</p>



INTERSTATE-McBEE





INTERSTATE-McBEE



INTERSTATE-McBEE, LLC

4901 Lakeside Avenue

Cleveland, OH 44114-3996 U.S.A.

Telephone: 800-321-4234

Telephone: 216-881-0015

Fax: 216-881-0805

Website: www.interstate-mcbee.com

e-mail: sales@interstate-mcbee.com